

TFD

Led high pole light



150W LED HIGH POLE LIGHT

(Product specification)



Brand	
Product name	150W LED high pole light
Product number	
Date	2019.03.13



TFD

Led high pole light

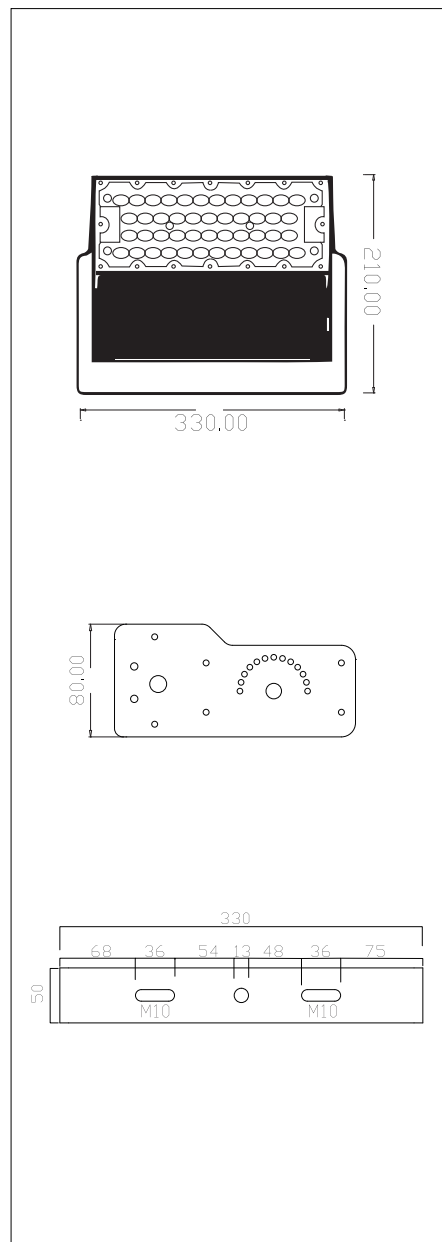

TFD

Led high pole light



TFD

Led high pole light



Technical Parameters

Product Number	TFD-150W		
Input Power	150W		
Lamp Brand	Philips SMD3030 184PCS	Philips SMD5050 46PCS	
Light Effect	145lm/W	165lm/W	
Input Voltage	AC100-305V	Frequency	50-60Hz
Power Factor	PF≥0.95	CCT	2700-6500K
Power Supply	Meanwell ELG 150W*1PCS	CRI	≥70
Product Size	330*230*80mm	Package size	340*240*102mm
Net Weight	4.35KG	Gross weight	4.75KG
Lamp Body Color	black	Silver	
Power Cable	Brown L firewire		
	Yellow green G ground		
	Blue N zero line		
Beam Angle	8°/20°/40°/60°/90°/140°*100°		
Protection Level	Protection class IP67 resistant to 17 winds	Material	Fin 1060 pure aluminum
Service Life	50000 hours	Temperature	-30 +55
Certificate	CE RoHS	Warranty	5 years

TFD

Led high pole light



Single module adjustment angle light distribution, 8°/20°/40°/60°/90°/140°/100° angleless PC cover



Import Philips LED lamp beads, Light efficiency>165LM/W

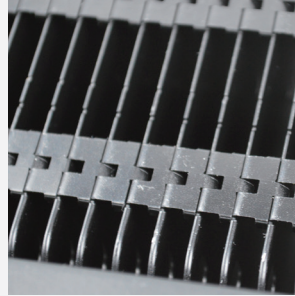

Using fins 1060 pure aluminum heat dissipation, air convection design, Better heat dissipation, heat sink 0.5mm



Use 304 stainless steel screws



Internal wiring is waterproof, safe, Convenient.



Meanwell ELG or HLG driver



Independent power box design to support more power, which is beneficial to light body heat dissipation, reducing light decay and prolonging service life



Refined iron phosphide bracket

Design Features

Product packaging

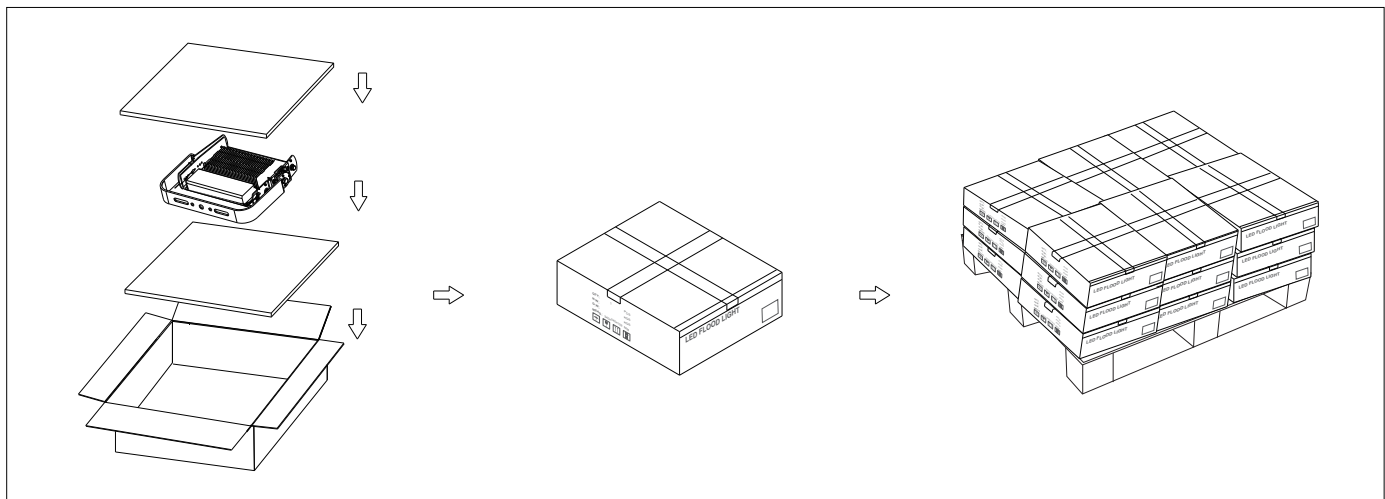

TFD

Led high pole light



★Instructions for use

1. This product uses working voltage: AC100-305V 50/60 Hz, please do not exceed the working voltage range;
2. Since the lamp has a PC lens accessory, please take care when handling and storing it, and do not press it.

★Installation instructions

1. The mounting rod or mounting surface can be directly screwed through the mounting hole on the product mounting bracket;
2. After fixing the product, you can loosen the screws on both sides of the bracket and then change the angle of the bracket, which is equivalent to adjusting the installation angle of the fixture;
3. Working environment temperature -30 °C-+55 °C storage;
4. When installing the luminaire, the wiring and wiring are closed to prevent leakage;
5. When the external power cord is connected, the corresponding waterproof and water leakage measures must be taken;
6. Anti-glare design, uniform light distribution;
7. Independent power supply box design is beneficial to heat dissipation of the lamp body, reducing light decay and prolonging the service life of the light source;
8. Support light sensor installation, which can realize intelligent control of lamps and improve energy saving benefits.

★Maintenance and repair instructions

1. Make sure that the power has been turned off before maintenance.
2. Regularly clean the PC lens of the floodlight to maintain the high transmittance of the lamp;
3. Regularly clean the dust of the floodlight casing and radiator to maintain good heat dissipation performance;
4. Be careful not to clean with water or corrosive solutions, preferably with a dry rag;

★QUALITY ASSURANCE, AFTER-SALES SERVICE

The whole lamp is guaranteed for 5 years. Under normal conditions of use, quality assurance is based on the proper storage, installation, use and maintenance of the product; Due to improper installation and use, product damage caused by violation of product operating procedures is not covered by warranty; For quality problems during the quality warranty period, the company will choose to repair, exchange (parts) or replace new products during the warranty period. The method is solved; if the quality warranty period is exceeded, the materials and labor costs will be properly collected.