

1000W 1200W

Transfo LED HIGH MAST LIGHTS

► FEATURES & BENEFITS

- IP65 rated LED floodlight
- Rotatable modules offering maximum customisation
- Heavy duty stirrup mounting bracket
- Multiple optics available
- Can be installed as a floodlight or high bay
- With illumination equivalent to 2200 watt and 2500W metal halide fixtures you'll enjoy an "instant-on, flicker-free" cold start, and industry-leading 155-160Lm/W.
- Protractor scale for easier aiming
- 50,000-hour operating life means years of maintenancefree operation.
- Unique design extracts heat from the light source, thereby extending component life and ultimately prolonging the useful life of the fixture.
- Lightweight design provides easy retrofitting of existing HID installations, along with quick mounting on all new installations.





Transfo LED HIGH MAST LIGHT 1000W 1200W

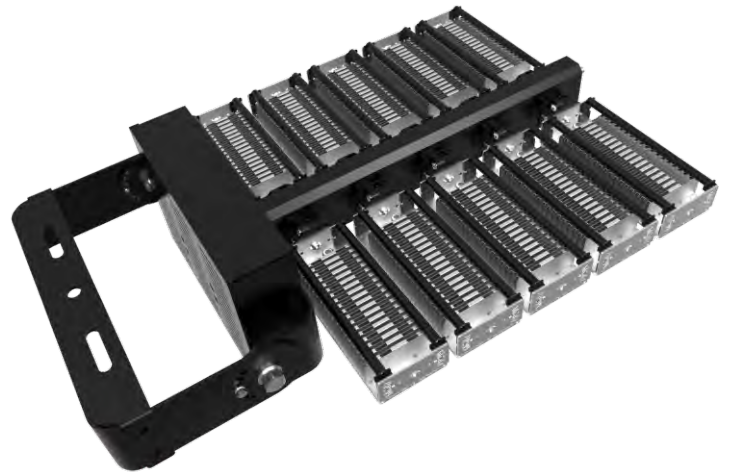
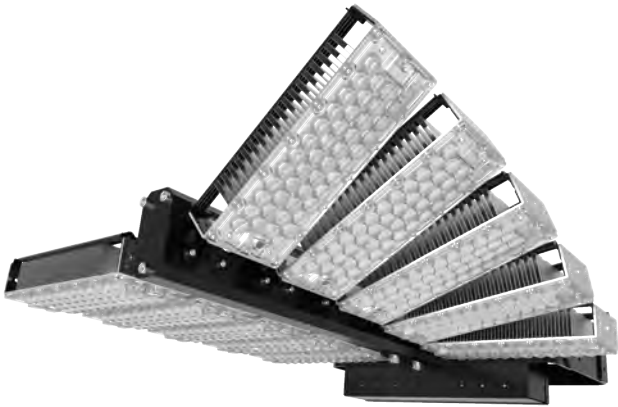

▼ DIMENSIONS

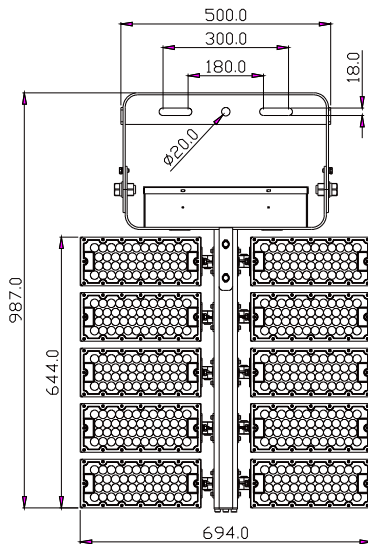

◀ Length: 27.3 in (694 mm)

▲ Height: 38.8 in (987mm)

▼ Width: 10.5 in (268 mm)

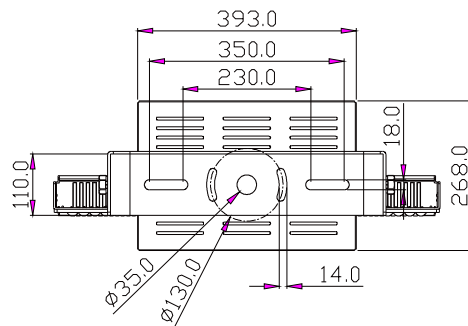

▼ PHOTOMETRICS

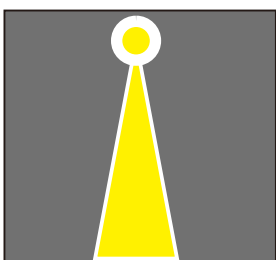

20°

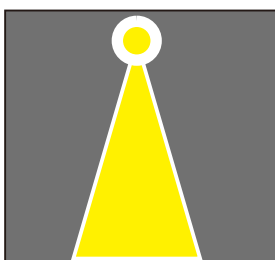

40°

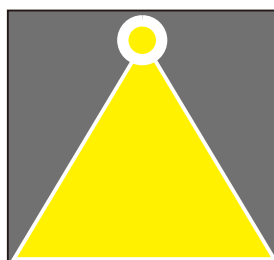

60°

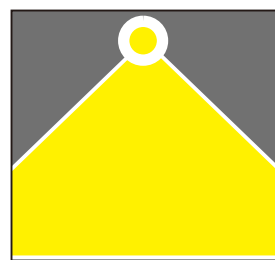

90°

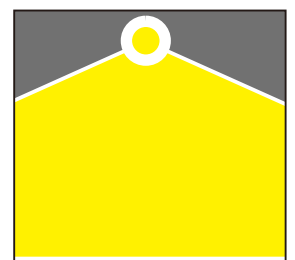

120°



All Applications

- Uniformity and light quality
- Light pollution and spillage
- Controls



Baseball, Softball

- High levels of illumination
- Lighted from all sides
- Reducing glare



Harbors, Wharfs

- Pole location (primarily sidelines)
- Pole quantity
- Number of fixtures per pole



Soccer, Lacrosse, Mixed Use

- Pole location
- Pole quantity
- Number of fixtures per pole



Basketball, Tennis

- Floodlight, or area-style fixtures
- Court configuration (grouping)
- Court access



- 1 ▶ Rotatable module
- 2 ▶ Replaceable optical lens
- 3 ▶ Protractor scale for easier aiming
- 4 ▶ Lengthened heavy duty mounting Bracket allowing for 360° rotation
- 5 ▶ Salt spray resistant, corrosive resistant, processed with dedicated treatments on the heat sink and other components, these fixtures can withstand corrosive and salt intensive environments.

LED HIGH MAST AREA LIGHT SPECIFICATION SHEET



▶ OPTICAL SPECS

LSTHM-B1000W-LV(XXK)

LSTHM-B1200W-LV(XXK)

Efficiency:	Up to 160 Lm/W±3%	Up to 155 Lm/W±3%
Lumen:	160,000 Lumens	186,000 Lumens
Color Temp:	3000K / 4000K / 5000K / 5700K	
Light Source:	Lumileds 5050	
Beam Angle:	20° / 40° / 60° / 90° / 140*100°/ Milky PC 120°	

▶ ELECTRICAL SPECS

Wattage:	1000 Watt	1200 Watt
Input Voltage:	100-277VAC	
Power Frequency:	50/60 Hz	
Driver:	Sosen 5*SS-240V-54 / Meanwell 5xELG-240-48A	
Dimming:	Dimmable / Non-dimmable	

▶ OTHER DETAILS

Fixture Material:	Marine grade aluminum
IP Rating:	IP65 (TUV report available)
Module rotatable:	Module rotatable up & down 15°
Lifespan:	>50,000 Hours
Dimensions:	38.8 x 27.3 x 10.5 in (987 x 694 x 268mm)
Certificates:	ETL, cETL, DLC, TUV, CE, SAA, LM79, LM80, ISTMT, LCP



LED HIGH MAST LIGHT

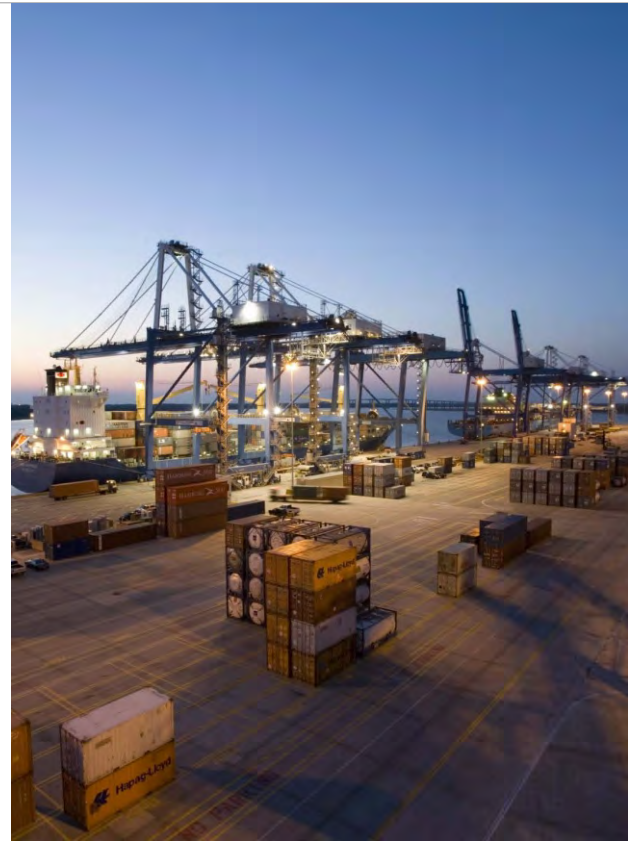

APPLICATION

- ▶ Outdoor lighting
- ▶ Security lighting
- ▶ Industrial lighting
- ▶ Sports field lighting
- ▶ Construction site lighting
- ▶ Highmast lighting

▼ ADJUSTABLE MOUNT

