

**LN Lighting technical data**

# **LED 200W SHOE BOX LIGHT**

**Lighting technical data**

**LED SHOE BOX LIGHT is an alternative light source  
with longer life and uniformed light distribution**



**IP65**

# LED SHOE BOX LIGHT

## mounting bracket

model	Dimension(mm)	Material	coding
SBL-A		ADC12	4.12.27015900
SBL-B		ADC12	4.12.27016000
SBL-C		ADC12	4.12.27016100
SBL-D		Iron	4.12.41016300

SBL : A

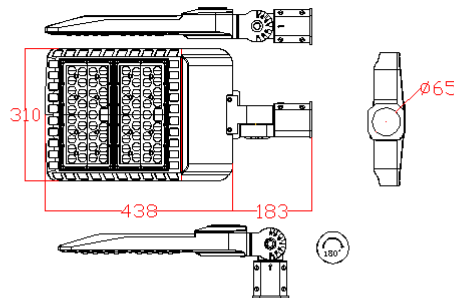

SBL : B

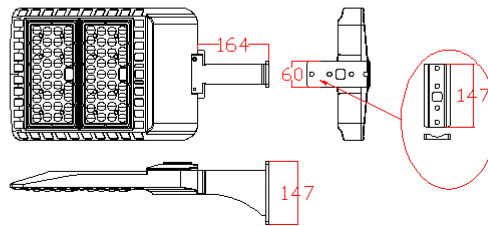

SBL : C

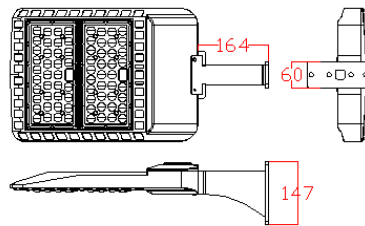

SBL : D

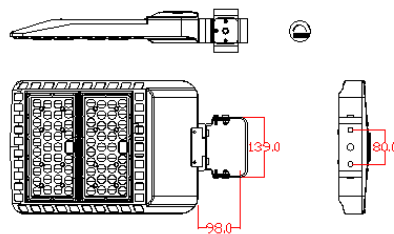

## LED SHOE BOX LIGHT



## Line-Up

Model No.	Watts(W)	Light Output(lm)	Dimension(mm)	Light Color(K)	Beam Angle(Degree)
LN-SBL200-U-N-QW-BR-U-III-00	200±10%	26000-10%	438*310*72mm	5000K	80*150

## Technical Specifications

Item	Test Conditions	Min.	Typ.	Max.
Input Voltage(V, rms)	AC	120	220	277
Input Current(mA, rms)	AC(120V)	---	901	---
Input Power(W, rms)	AC(All)	---	200	---
Input Frequency(Hz)	AC	---	50Hz	---
Power Factor(PF)	AC(All)	≥0.9		
Output Voltage(V)	DC	61	63	64
Output Current(A)	DC	1.43*2	1.45*2	1.46*2
Output Power(W)	DC	174.5	182.7	186.9

## Environmental Requirements

Specifications	Values
Operational Temperature Range	-40~40°C
Preservation Temperature Range	-40~90°C
Operational Humidity Range	95%Rh or below (@-40~40°C)
Installation Area	Outdoor (Counter,Residential,Commercial,etc)

# LED SHOE BOX LIGHT



Drawing

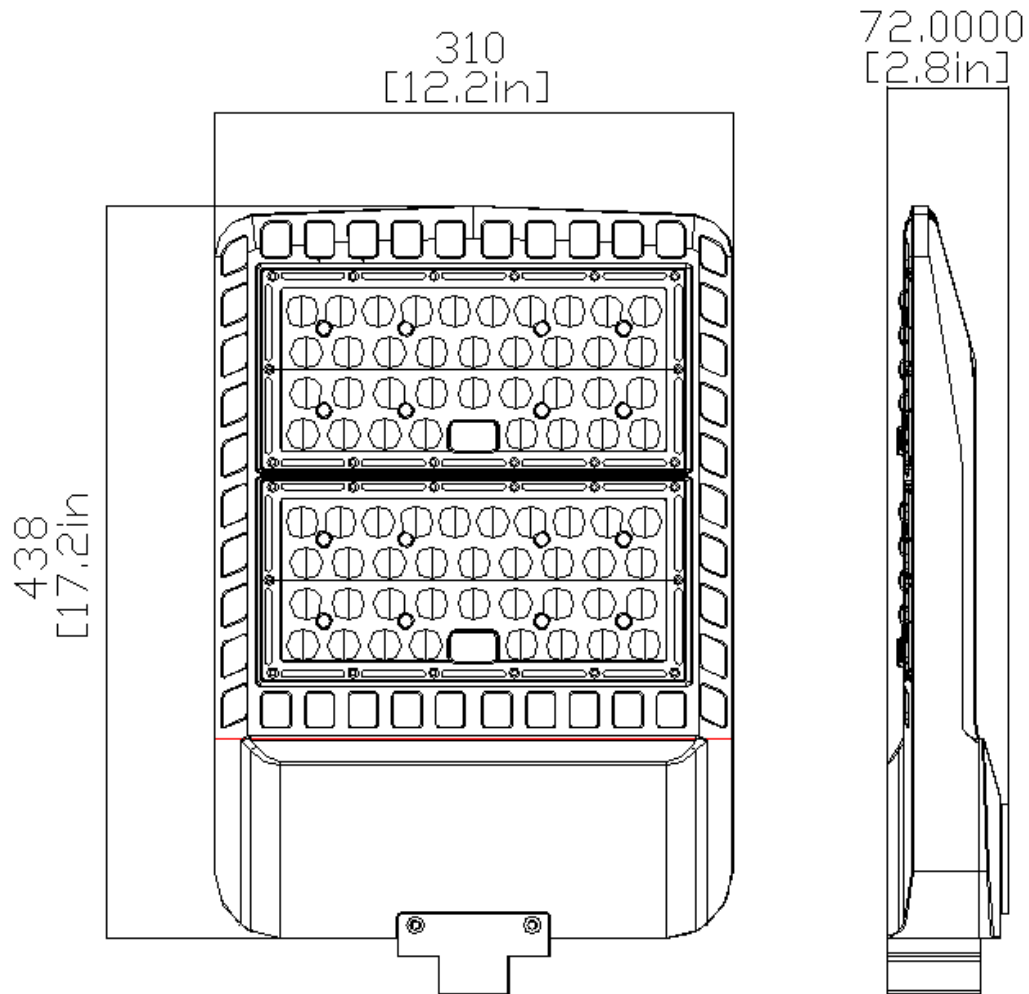

Material	IP
ADC12	IP65
PC	

# LED SHOE BOX LIGHT



LN-SBL200-U-N-QW-BR-U-III-00

Category	Specifications	Unit
Watts	200	W
Lumens per Watt(Efficacy)	130	Lm/W
Light Output	26000	lm
Light Color(CCT)	5000	K
Beam Angle	80*150	°(degree)
Color Accuracy(CRI)	70	Ra
Product Weight	3700	G
Rating Life	50000	H
Base	Line interface	
Input Voltage(AC)	220	V

Luminance Intensity Distribution

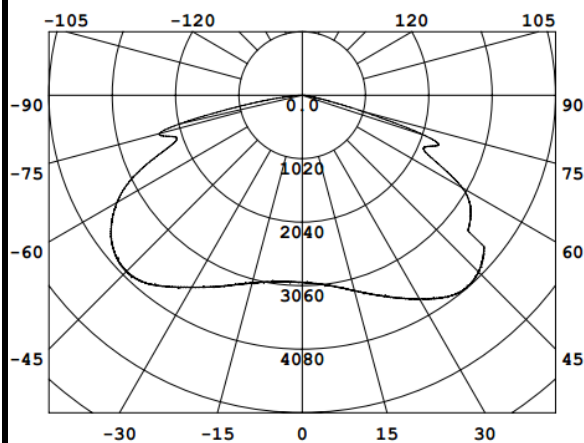
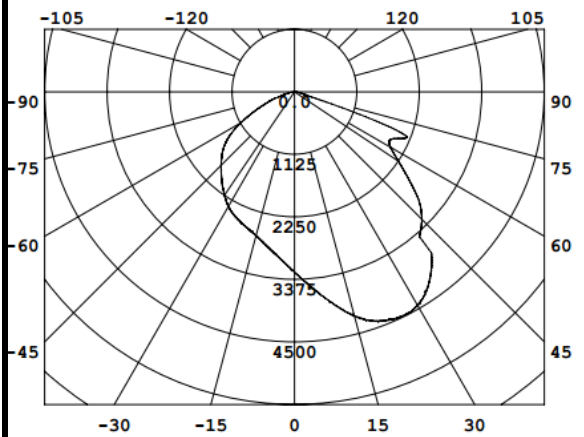

Cone Lux Diagram

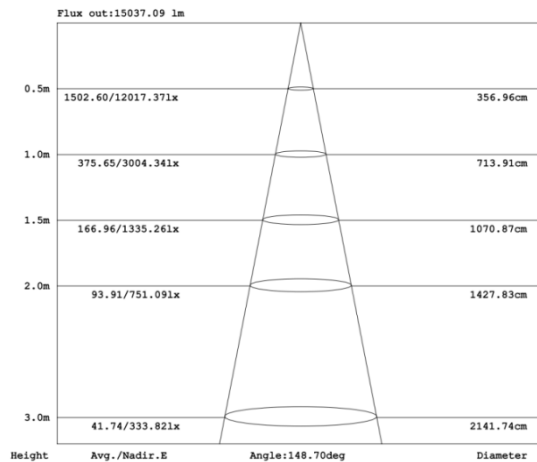
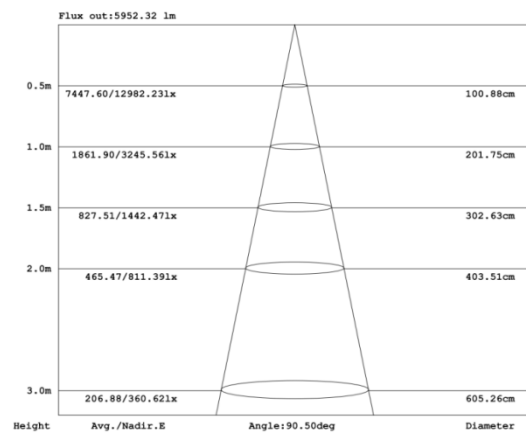

# LED SHOE BOX LIGHT



Product Packaging	Specifications	Unit
Product Dimension	438*310*72	mm
Net Weigh	4.8	Kg
Size of box	665*350*130	mm
Gross Weight	5.5	Kg
Size of Carton	665*350*130	mm
Qty/ Carton	1	PCS
Weight/ Carton	5.5	Kg

## Revision History

MTime	Changed to: VER	Description of Change		
		Item	From	To
2018.2.8	0.01	Size of box		665*350*130
		Gross Weight		4.3
		Size of Carton		665*350*130
		Qty/ Carton		1
		Weight/ Carton		4.3
2018.3.22	0.02	Net Weigh	3.6	4.8
		Gross Weight	4.3	5.5
		Weight/ Carton	4.3	5.5